

wybone

BWB Wheelie Bin Cover



Call: 01226 744010

Web: www.wybone.co.uk

Email: sales@wybone.co.uk

The Wybone range of BWB Wheelie Bin Covers has been designed with a number of important features in mind; manufactured from tough and durable galvanised steel to offer a corrosion resistant unit that is suitable for housing a variety of wheelie bin sizes.

- Pitched lid to deter standing rain water or debris.
- Premium quality galvanised steel, powder coated in RAL 9005 Black as standard.
- Self locking slam lock door.
- A selection of waste stream artwork is available.
- Logos or branding can be laser cut to the front of the bin or applied in vinyl.

Construction

Hot dipped coated galvanised material to BSEN10346 grade DX51D+Z275 offering outstanding corrosion resistance and rust protection.

Hot dipped galvanised thick laser cut base plate with 4 holes for ground fixing.

Single hinged door using concealed full length large diameter stainless steel rod pivot hinge with frictionless bushes to the top and bottom, with additional fixing in the centre of the rod to ensure the door remains fixed in place.

Surface Finish

Electrostatically primed and powder coated and oven cured.

Standard Features

Self locking door using stainless steel grade 316 slam lock, fixed with high tensile anti-tamper torx bolts.

10 Year Anti Perforation Warranty.

1 Year Parts & Labour Guarantee.

Sizes to suit wheelie bin capacities of 120 litres, 140 litres, 240 litres, 360 litres.

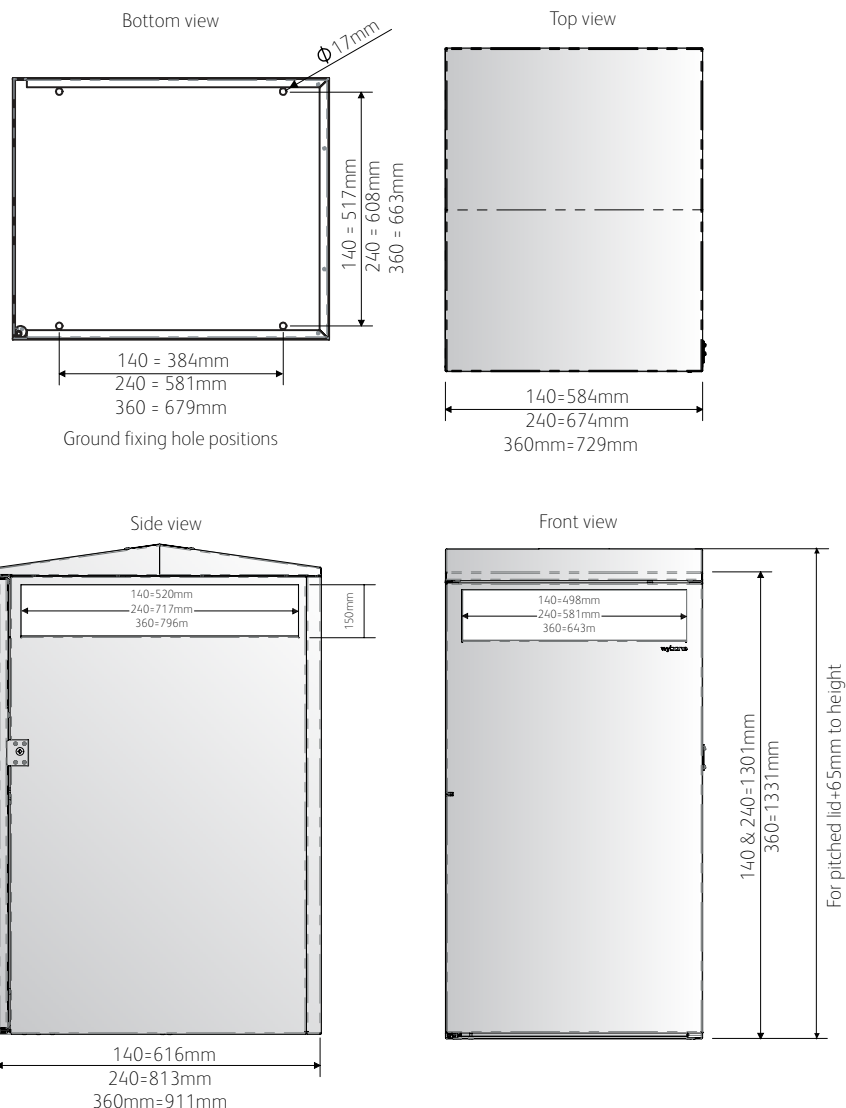









How to Order your BWB Wheelie Bin Cover

1

Colour Options

This product comes in black as standard, or you can choose any of the colours below:

As Standard:	Additional Colour Options:									
										
Black RAL 9005	Silver PCM30001	Grey PC7016	Dark Blue PC5013	Light Blue PC18E53	Dark Green PC6028	Green PC6005	Yellow PC1021	Red PC3020	Orange PC2004	

2

Lid Options



Standard Lid
LID/S | Inc. in price

The standard lid is slightly kinked to allow rain water to run off. This lid comes as standard and is included in the price.



Pitched Lid
LID/P | £20.00

A high pitched lid discourages anti-social behaviour, stopping people from sitting on the bin or leaving rubbish on top.

3

Smoking Options

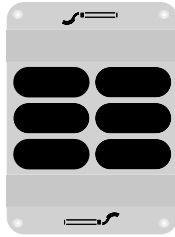

Pitched Ashtray
PITCH/AT | £79.00

Stainless steel self-emptying ashtray with stubber sections and large cigarette holes. A pendulum system ensures the contents empty into the liner when the ashtray is full. Fitted to the centre of the lid.

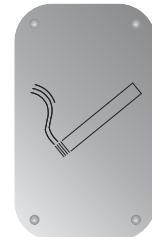

Stubber Plate
STUBBER/SS | £18.99

A stainless steel plate for stubbing out cigarettes and preventing unsightly marks on bins.

4

Aperture Options

(For additional options please see separate options sheet or contact us)

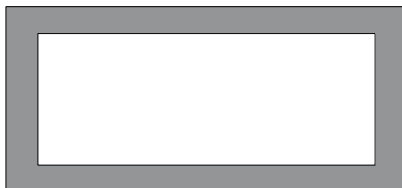

Standard Aperture
AP/ST

Used for litter and food waste

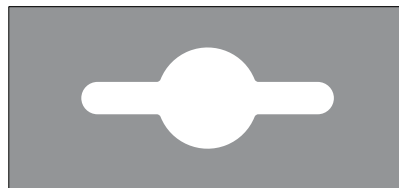

London Underground Aperture
AP/LU

Used for mixed recycling

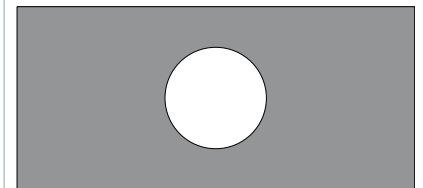

Circular Aperture
AP/C

Used for cans, plastic or glass bottles

5

Text Options

(For additional options please see separate options sheet or contact us)

LITTER

Laser Cut Gold | LC/LIT/GLD | £10.00
Laser Cut Silver | LC/LIT/SIL | £10.00

Vinyl Gold | V/LITT/GLD | £6.00
Vinyl Silver | V/LITT/SIL | £6.00

LITTER & DOG WASTE

Laser Cut Gold | LC/LDW/GLD | £10.00
Laser Cut Silver | LC/LDW/SIL | £10.00

Vinyl Gold | V/LDW/GLD | £6.00
Vinyl Silver | V/LDW/SIL | £6.00

RECYCLING

Laser Cut Gold | LC/REC/GLD | £10.00
Laser Cut Silver | LC/REC/SIL | £10.00

Vinyl Gold | V/REC/GLD | £6.00
Vinyl Silver | V/REC/SIL | £6.00

6

Artwork Options

(For additional options please see separate options sheet or contact us)



Tidyman Logo

Laser Cut Gold | LC/TM/GLD | £5.00
Laser Cut Silver | LC/TM/SIL | £5.00

Vinyl Gold | V/TM/GLD | £3.00
Vinyl Silver | V/TM/SIL | £3.00



A4 Mixed Recycling Artwork

A4 Vinyl Sticker | VR/MR2 | £15.00
A4 Perspex Plates | PPR/MR2 | £30.00

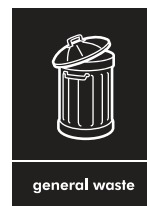

A4 General Waste Artwork

A4 Vinyl Sticker | VR/GW | £15.00
A4 Perspex Plates | PPR/GW | £30.00



Circular Litter & Dog Waste No Text Sticker

Gold | VLDW/NT/C/GLD | £5.99
Silver | VLDW/NT/C/SIL | £5.99



Circular Litter & Dog Waste Sticker

Gold | VLDW/C/GLD | £5.99
Silver | VLDW/C/SIL | £5.99



Contact us directly for a quotation.

Call: 01226 744010
Email: hello@wybone.co.uk

7

Optional Extra



Vinyl Banding
Gold | Band/GLD | £12.00 per band
Silver | Band/SIL | £12.00 per band

Vinyl banding around the circumference of the bin.



Advertising Pocket
A4 PF/PA4 | £16.99 each
A3 PF/PA3 | £21.99 each

Advertising panels cut out of the bin with a polycarbonate pocket to protect artwork.

How to Order your BWB Wheelie Bin Cover

8

Fixing Options

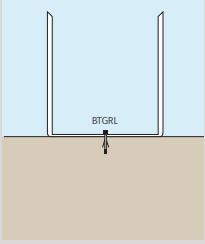

RAWL Bolts
BTGRL25 | £17.99

Set of 4 bolts for ground fixing with a pre-drilled base. The ground is drilled in the same arrangement as the fixing holes in the base of the bin. Bolts are placed in position and tightened to secure in the ground.

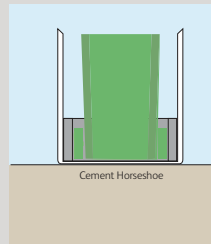

Internal Concrete Base
SLAB/F | POA

A cement horseshoe around the inside of the bin. This provides a concealed way to weigh the unit down and prevent it from being moved easily.

BWB Customisation Dimensions

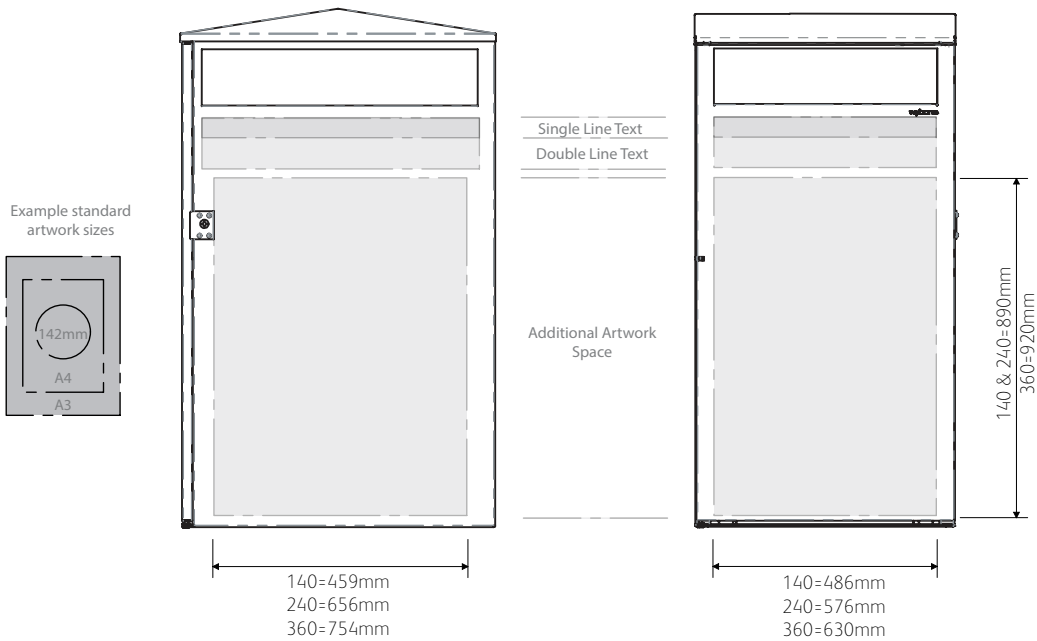

How to fit your BWB Wheelie Bin Cover

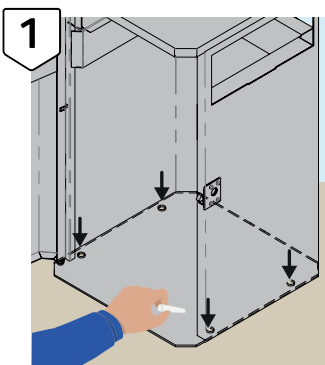

1 Position the bin with the door facing in the correct direction on flat ground without obstruction.

Use chalk to mark through the fixing holes onto the ground below.

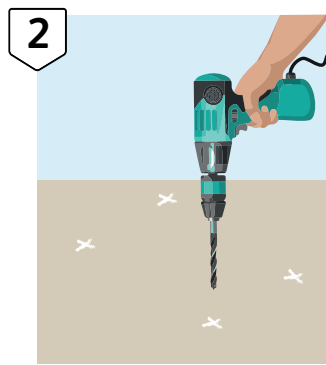

2 Remove the bin and mark the ground with a cross where the four hole positions are.

Drill 12mm holes in the 4 marked positions to a depth of 100mm or long enough to accommodate the bolt length.

Remove any debris from the holes.

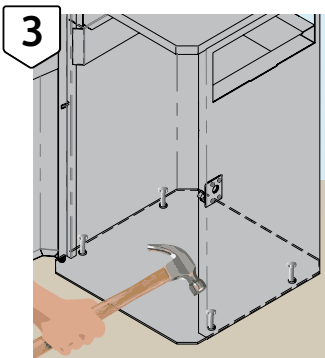

3 Position the bin over the 4 holes.

Fit bolts with washers into the holes and use a hammer / mallet to drive the bolts home.

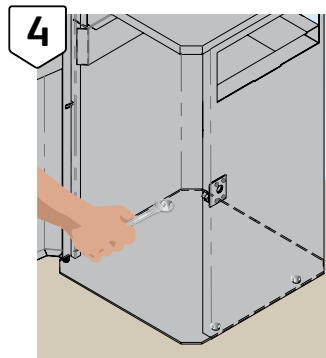

4 Use a spanner or socket to tighten the bolts. Tightening the bolts will fan out the bolt sheath in the hole holding the bin secure.

Replace the liner and shut the door.



The BWB range is manufactured from durable 2mm hot dipped galvanised steel, primed and powder coated in your choice of colour.



These wheelie bin covers are available in various capacities to fit from 120 litre wheelie bins to a sizeable 360 litres - ideal for light to heavy usage areas.



We've used the latest manufacturing techniques and state of the art machinery to reduce emissions and produce a litter bin that offers a small carbon footprint and is as ecologically friendly as possible.



The larger capacity units are perfect for busy streets, sea fronts and outside shopping centres where it may not be easy to empty on a regular basis.

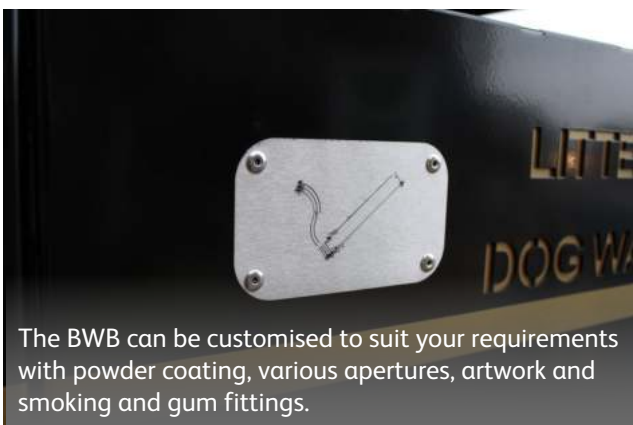

The BWB can be customised to suit your requirements with powder coating, various apertures, artwork and smoking and gum fittings.



The BWB comes with a flat lid as standard or choose our pitched lid to prevent rubbish being left on the top, with an optional pitched ashtray.